

IR Repeater Kit Instruction Manual

The **IR Repeater Kit** connects IR Connecting Block, IR Receiver, IR Emitter, and Power Supply together to interface the IR system to the audio/video components.

Related Components:

IR Connecting Block
& Mounting Screw x 2 pcs

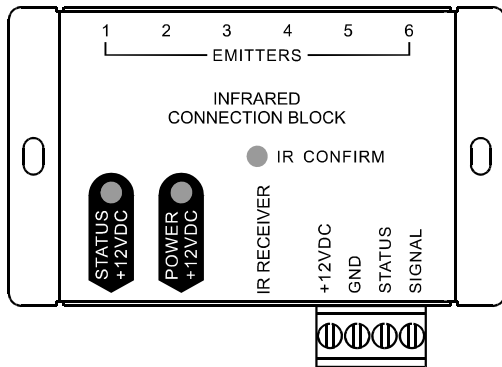

IR Receiver

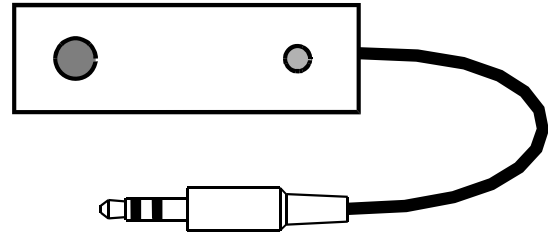

Dual IR Emitter

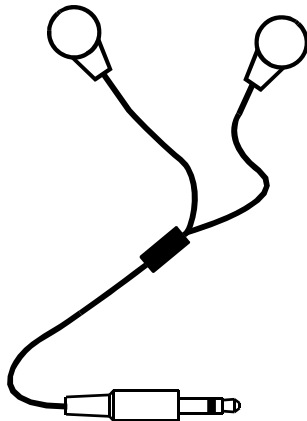

Single IR Emitter

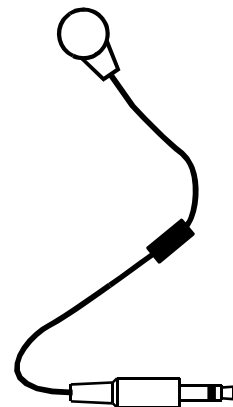

In-Wall IR Receiver

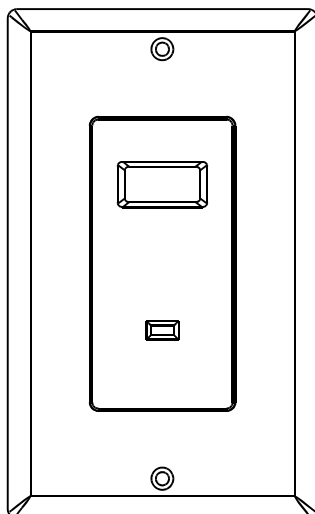

Power Supply x1

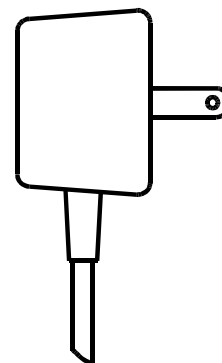

◆ IR Connecting Block

FEATURES

1. Six emitter output connections.
2. Convenient IR confirmation LED.
3. Status power receptacle with LED indicator.
4. Power receptacle with LED indicator.
5. Three conductor 1/8" receptacle for interfacing with many brands of freestanding IR receivers.

INSTRUCTIONS

① Power

Connect a 12 VDC (200mA to 1A) power supply to the power jack of the IR Connecting Block. The red LED will be illuminated when powered. This will power all of the IR components connected to the system. Depending on the type of components and the number of components will determine how much current the power supply will need to provide.

② Status Power

12VDC 200mA 2.1mm + Tip – sleeve.
Connect a power supply to this connection will power the status connection. The green LED will be illuminated. This can be from a 12 volt trigger output or from a wall type power supply plugged into a switched outlet of a stereo receiver. If you are using products like the In-Wall IR Receiver that have a status indicator, simply plug a 12 VDC power

6. Large detachable IR receiver connection.
7. Compact size for mounting near audio equipment.

SPECIFICATIONS

Dimensions: 82W x 60H x 27D mm

Weight : 110g

supply into the switched outlet and when the receiver is turned on the status LED will be illuminated.

③ IR Receiver Connection

This is a three terminal 1/8" plug that is common to many of the free standing IR receivers. This will connect the power, ground and signal. Signal is Tip, ground is the ring and power is the sleeve.

④ In-Wall IR Receiver Connection

(Purchased separately)

Connect the In-Wall IR Receiver to the detachable connector labeled +12VDC, GND, STATUS, and SIGNAL.

⑤ Emitter Outputs

Connect up to 6 emitters to the emitter jacks labeled 1-6. Place the emitters on the source equipment.

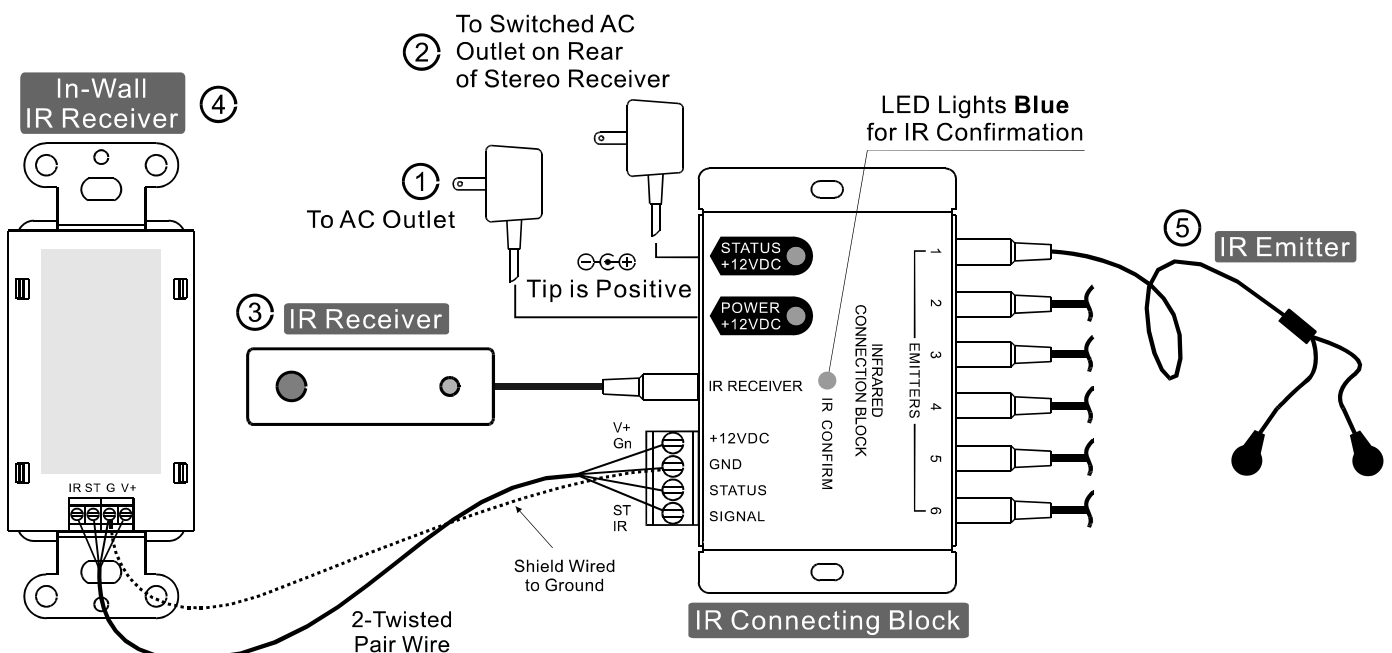

◆ IR Receiver

Features

1. CFL friendly—allows installations in areas with compact fluorescent lighting. Works in most lighting environments.
2. Blue IR confirmation LED.
3. Wide band IR receives IR from many types of remotes.
4. Self-adhesive tape for quick and easy fixing on any flat surface.
5. 3 meters cable with 3.5mm stereo mini-plug.

Specifications

Receive Frequency Range.....	34 kHz to 60 kHz
Transmit Frequencies.....	38 KHz & 56 KHz
Range.....	40ft. @ 38 KHz
.....	25ft. @ 56 KHz
Power.....	12VDC, 30mA max.
Dimensions.....	45L x 14W x 13H mm
Cord Length.....	10ft (3m)
Connector Type.....	1/8" (3.5mm) TRS mini plug
Weight.....	28 g

Wire connections

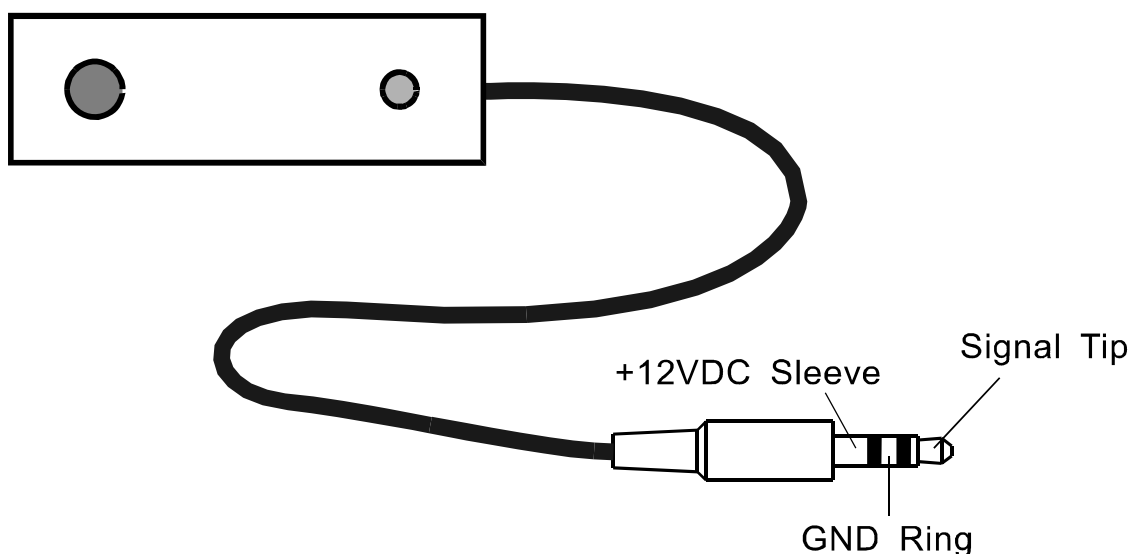

◆ Dual IR Emitter

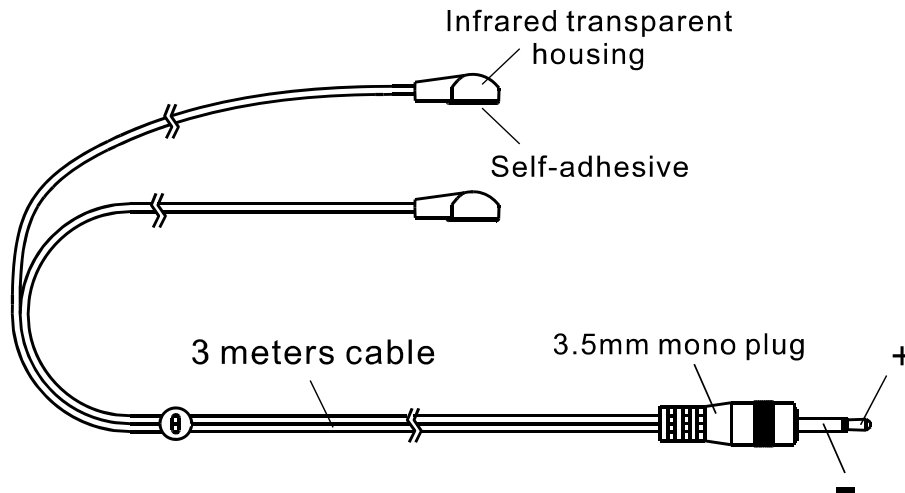

A. Standard installation

1. IR emitter attached directly to IR sensor window.
2. Most reliable activation

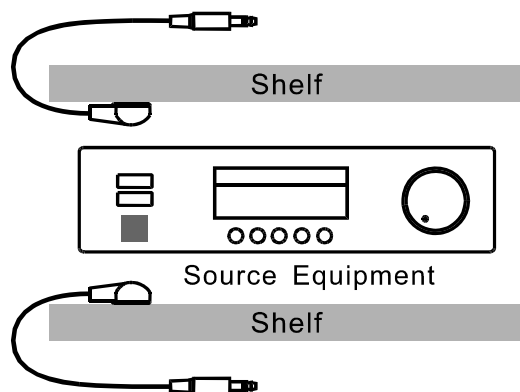
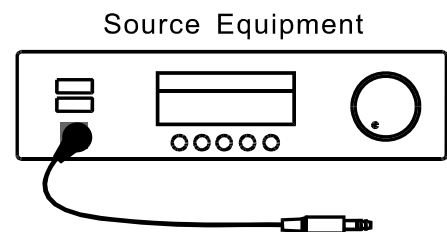

B. Attach emitter on inside shelf

1. Attach emitter on shelf above or below IR sensor.
2. Less reliable activation.

C. Cabinet with door installation

1. Attach emitter on door, round shape facing the IR sensor.
2. Less reliable activation.

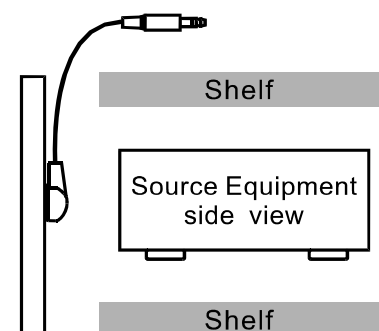

Note: Occasionally, more reliable activation can occur by moving the IR emitter further away from the device. This may be due to improper placement of the emitter, or that the sensor itself is partially obscured. It may also be due to a peculiar remote control unit / sensor combination. Placing the emitter 5~10cm away from the IR sensor can achieve significantly better activation in such cases. Please experiment to achieve optimal activation before securing with the self-adhesive pads.